

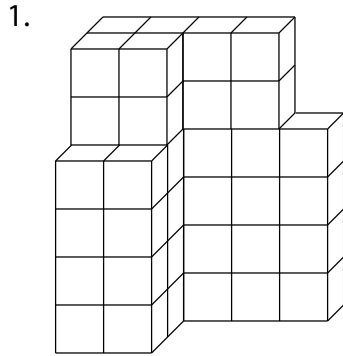

Name : ..... Class : .....

## Volume cubes proportion

Determine the number of cubes.



---

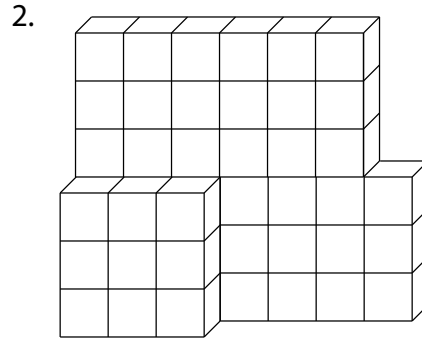

---

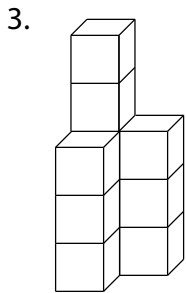

---

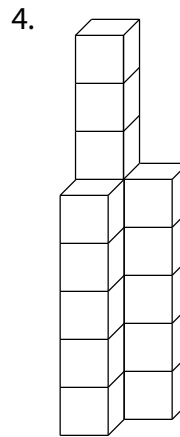

---

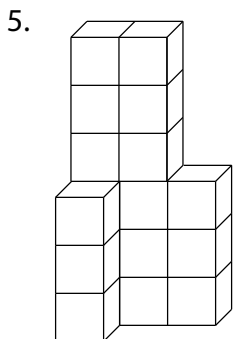

---

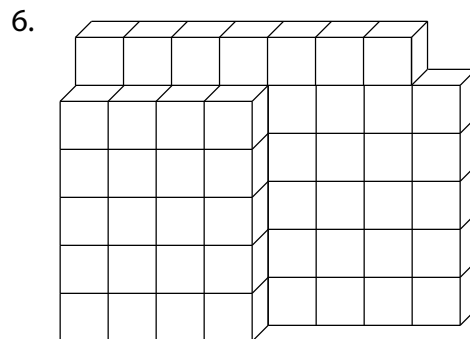

---

7.

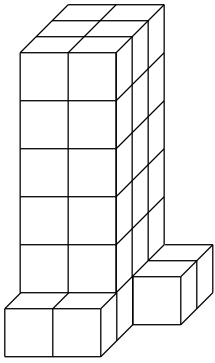

8.

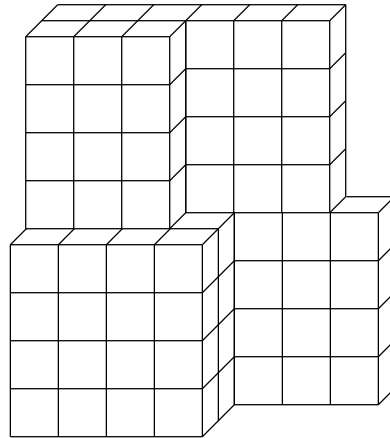

9.

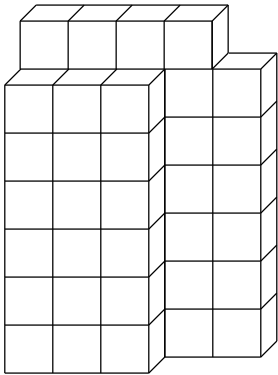

10.

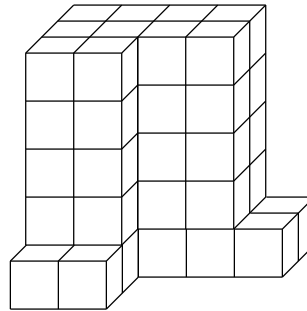

## ANSWER SHEET

Determine the number of cubes.

1.

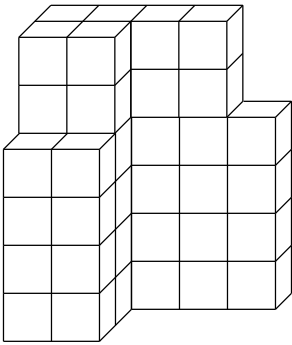

48 cubic units

---

2.

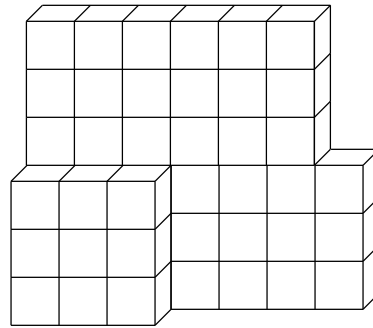

48 cubic units

---

3.

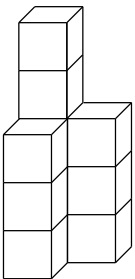

11 cubic units

---

4.

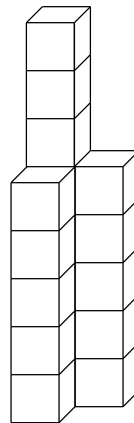

18 cubic units

---

5.

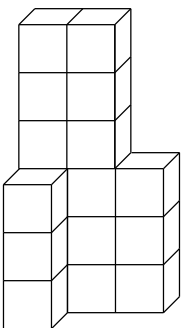

18 cubic units

---

6.

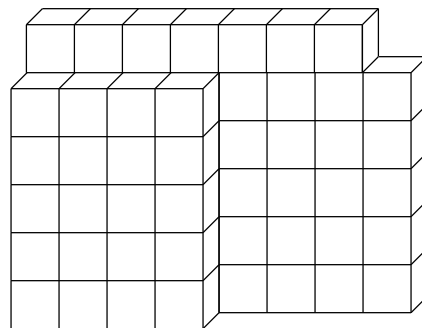

67 cubic units

---

7.

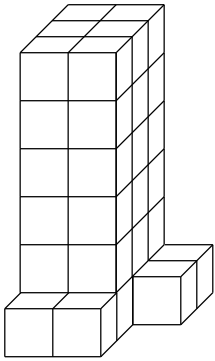

40 cubic units

---

8.

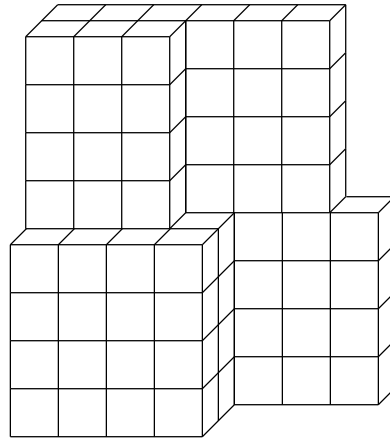

96 cubic units

---

9.

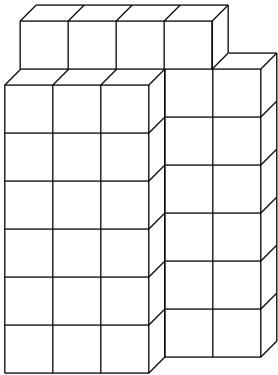

52 cubic units

---

10.

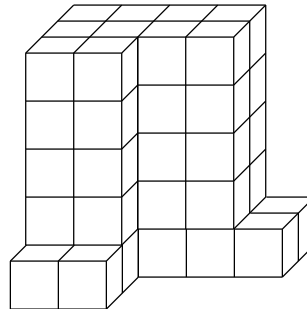

54 cubic units

---